

Armored Sink 26" x 20" – U/M



Kitchen Sinks

Code: 1238 660

AISI 304 Stainless steel

Satin finish

Undermount

x cross bending for easy water draining



DETAILS

Edge/Installation Type	Undermount
Series	Quadra Armored
Texture	Satin
Material	AISI 304 stainless steel
Thickness	16 Gauge (1.5 mm)
Overall dimensions	26" x 20"
Bowls dimensions	1 bowl 24" x 18"
Bowls depth	10 "

Cut out 24" x 18"

Waste fitting type 3 1/2" - with stainless steel basket

Bowls bottom X cross bending for easy water draining

Underside Protected with heavy duty undercoating

Fixing system Undermount fixing kit (brass insert and clips)

FEATURES

Diamond-shape bottom The draining of water is an important feature in a sink, and it's always taken good care of in Foster products. In the bent-welded sinks, which would have a flat bottom, the proper draining is guaranteed by the elegant beveling, which helps the water flow.

High thickness 1.5 mm thick steel. A significant thickness, which guarantees the maximum sturdiness and durability.

Basket 3,5" waste fitting The drain is equipped with a large 3.5" drain, with the practical basket cap that prevents the discharge of solid parts.

Deep bowls This bowls reach an important depth, over 20 cm, thanks to the advanced production technology, that can be offer great capieny and practicity in all the washing operations.

TECHNICAL DATA

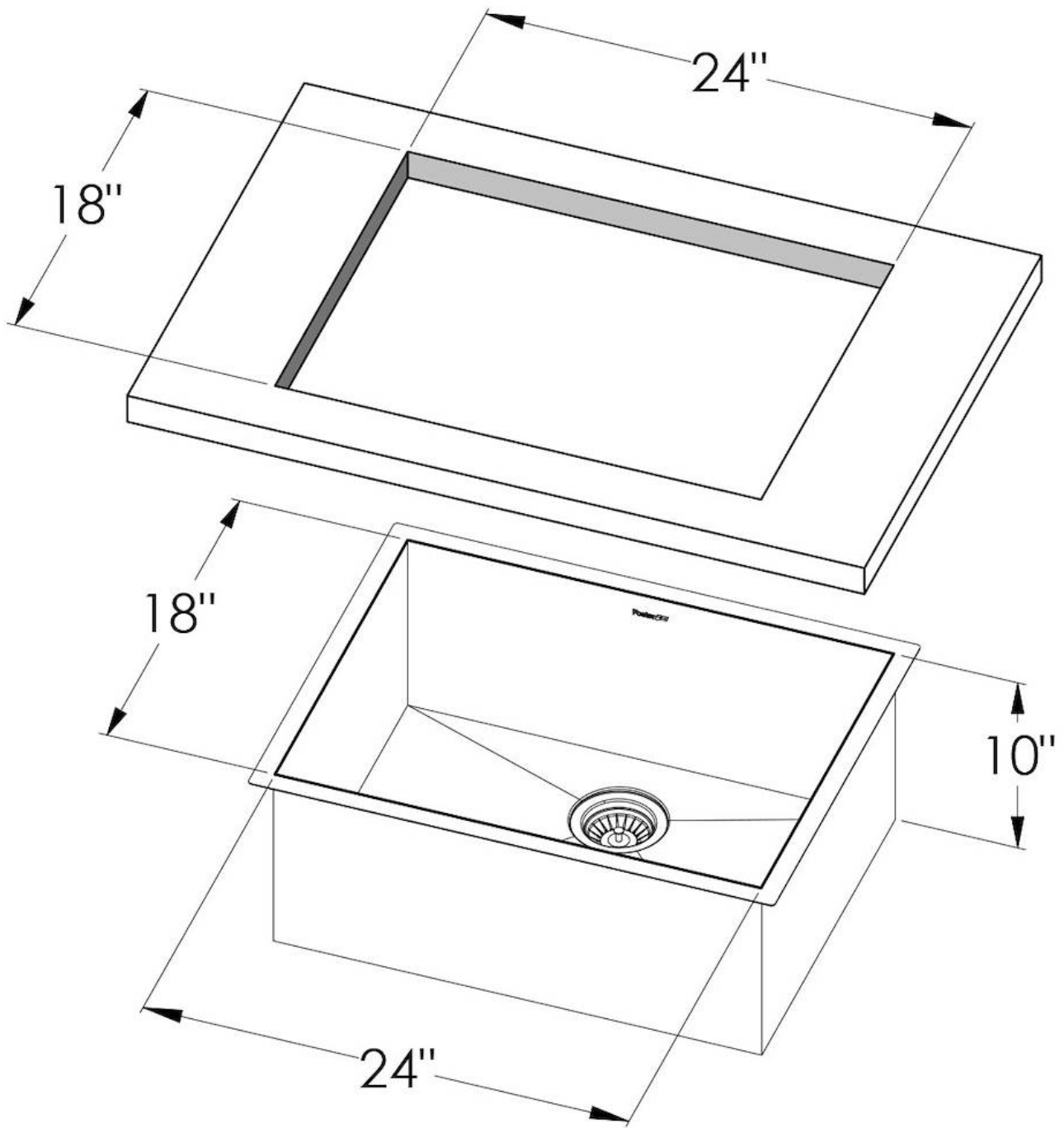

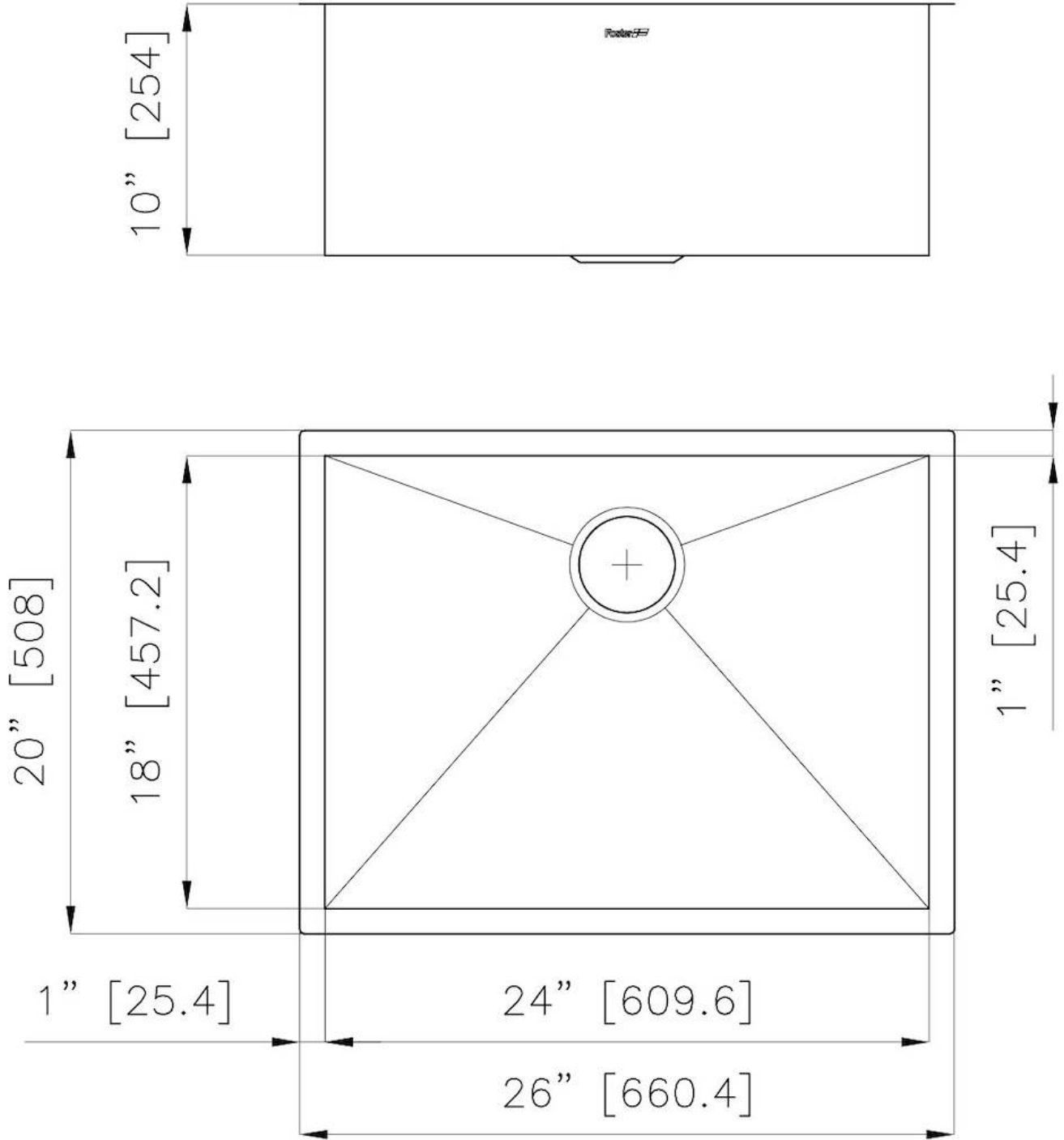

OPTIONAL ACCESSORIES



Waste disposer throat
8669 043

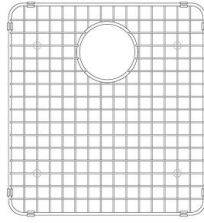

Grid
8100 402



Stainless Steel dishes holder
8100 154
* only in combination with the accessory
8644 034



Stainless steel perforated pan
8154 000
* only in combination with the accessory
8644 034



Chopping board
8644 034

RECOMMENDED PAIRINGS



Faucet Ponza
8497 025



Faucet Sicilia
8485 005



**Quadra Line Cooktop 4 burners
inLine**
7217 942



Milano Induction Cooktop 2 Plate
7323 945